

# Maxon<sup>+</sup>



Adjustable Plastic Pedestals

# If we save nature nature will save us as well...

Maxon uses modern ecological luxury is, comfort structure focused, and anti global warming. At the same time human health and environmentally friendly products are used for all applications. Moreover, Maxon continuously works on product development and industrialization, with guidance from customer satisfaction and feedback.





# What is Pedestal Premium?

Plastic raised floor pedestals are used in trafficable and non-trafficable flat roofs in order to reach the desired final level and to remove slope differences. The purpose here is to make the top coat flooring without placing a protection alum on the insulation. And to establish a consistent drainage system by means of the open joint gaps of the floor cover. At the same time, these pedestals establish a system, which is open to interference any time, are also quite durable with their min. bearing capacity of 2000 lbs.





for outdoor tiles...



for outdoor laths...



# Safety Level Release Button



The safety level release button on the top pedestal unit or coupler ensure that the pedestal is used in the safe height level in the application phase. In this way, the pedestal is used in accordance with standards and the safety of the users is ensured.









# Adjustable Pedestal Premium

Works efficiently between  
1.125" to 42.5"

Coupler must be used when the system is longer than 7 inches. Multiple auxiliary parts can be applied the same unit. Electrical lines and water lines can be attached easily on the units. This system gives technical benefits and clear transportation.

Code: T-C

There is no need to stabilize the bottom pedestal on the surface due to its broad diameter. However there are number of gaps for making the unit stable if desired. Corner and edge details have trim lines to solve distance problems. Bottom edges have bevels to give smooth touch on insulation.

Code: BASE

Made from EPDM, the orthopedics floor pad can absorb vibration caused from rough surfaces.

Code: T-P

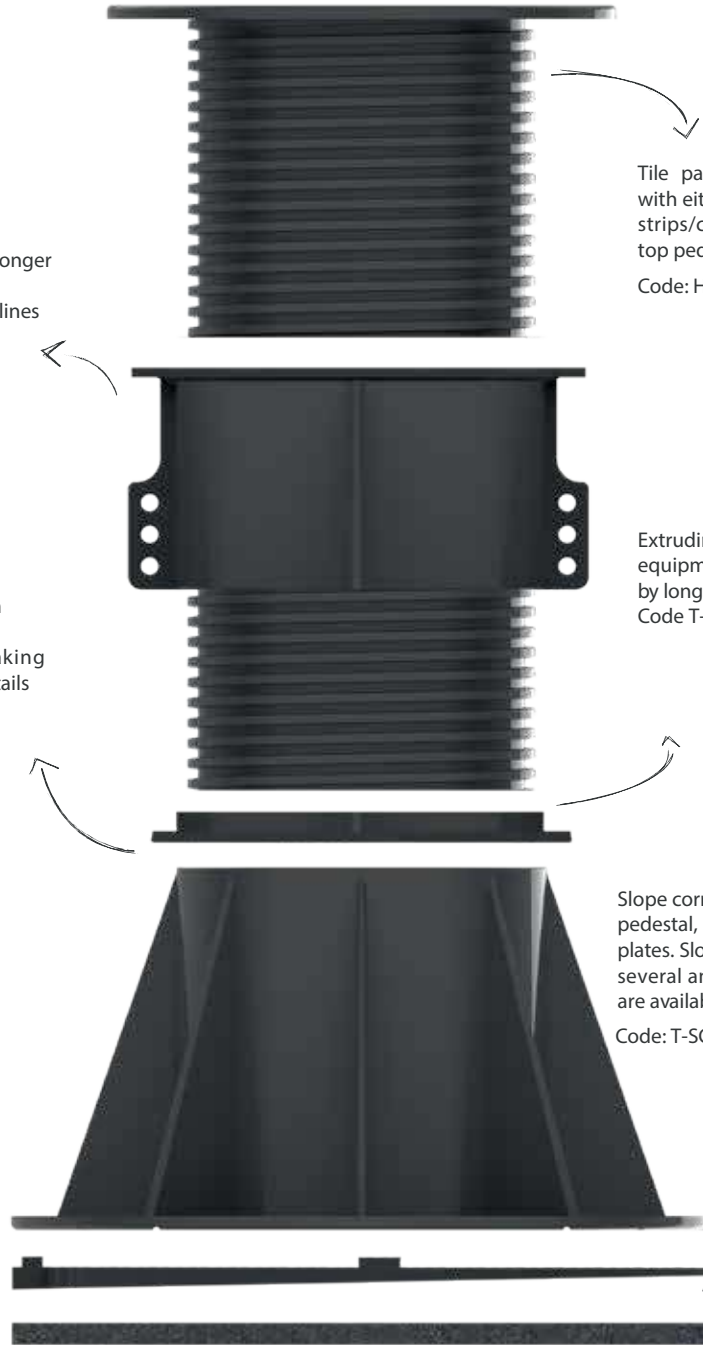

Tile pavement or Lath pavement is possible with either placing auxiliary equipment or joint strips/carcass assembly equipment on the top pedestal unit's holes and adjustable gaps.

Code: HEAD

Extruding lock is usually used for high grades. This equipment avoids adjustment corruptions caused by long run vibrations.

Code T-L

Slope corrector, working with the bottom of the pedestal, avoids pressures of drain slopes on plates. Slope corrector can tolerate an degree several angles. Alternatives of 1% and 2% are available.

Code: T-SC

# Setting Ranges



Up to 7 inches height, there is no need for coupler usage.

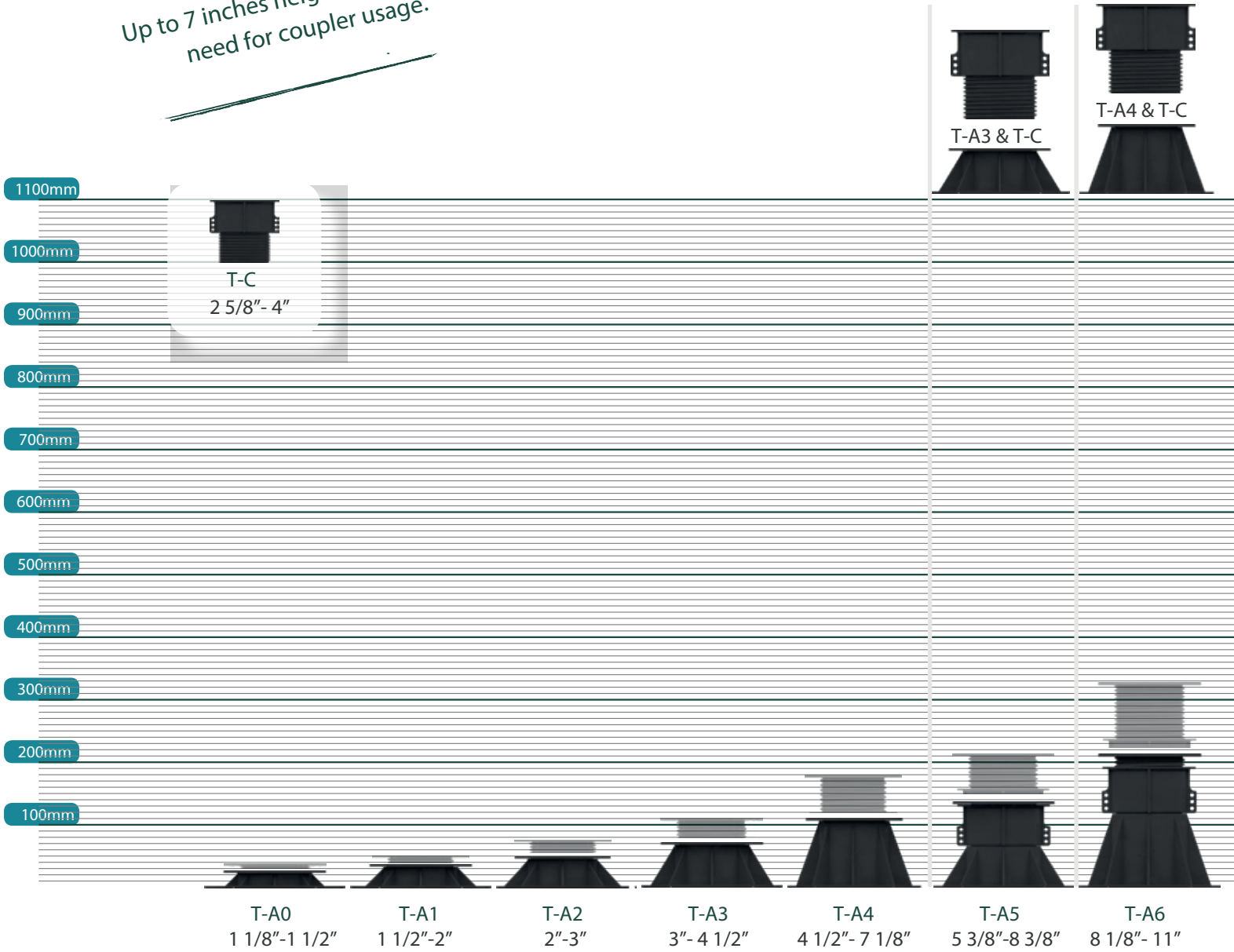

# Setting Ranges

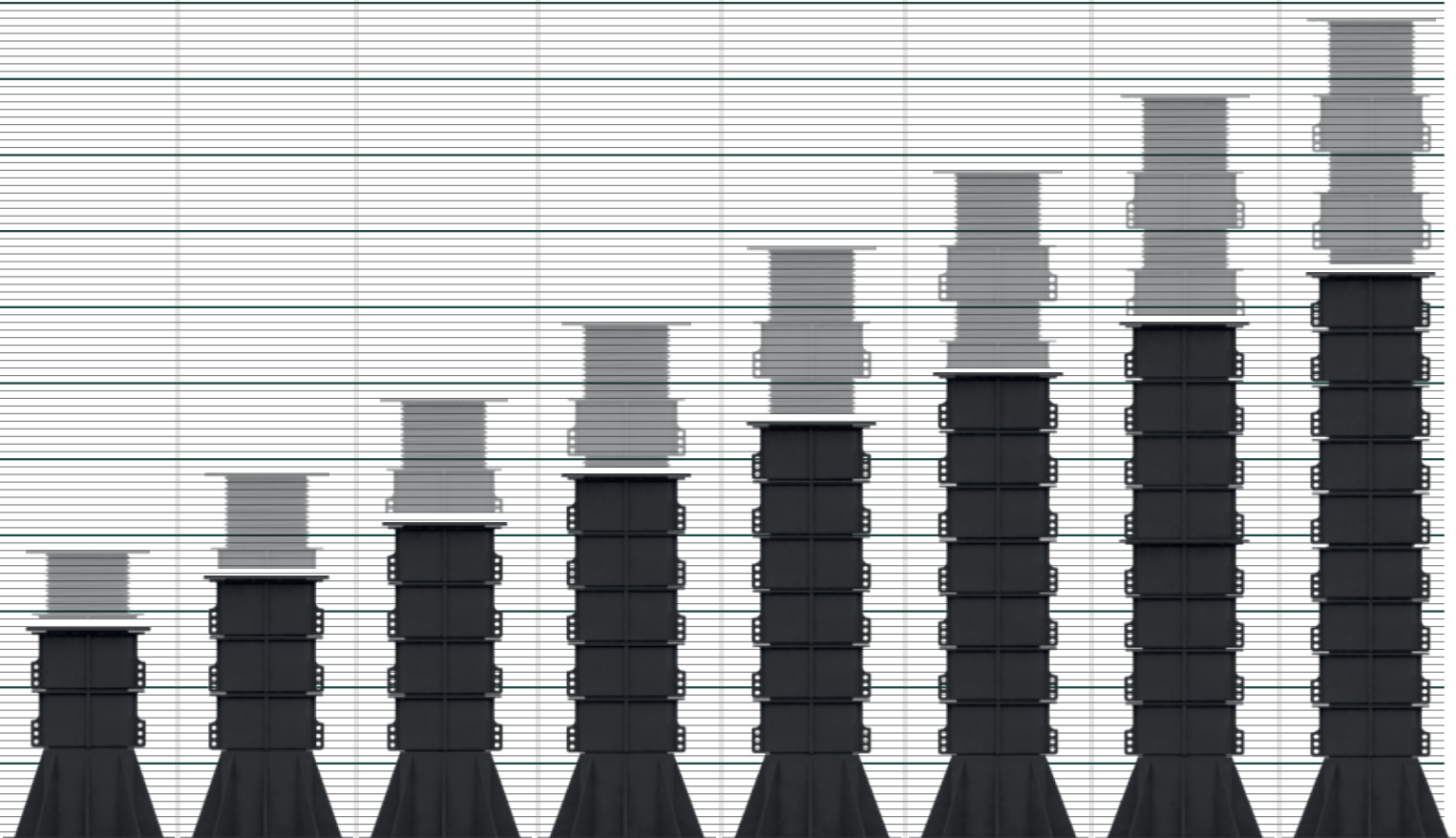
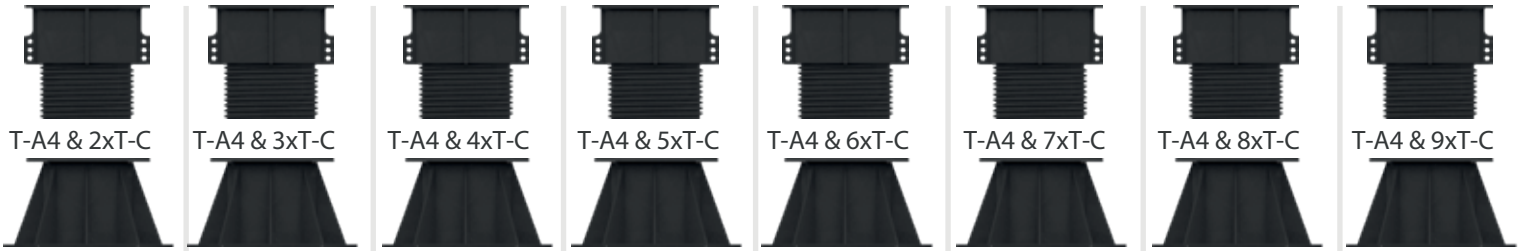

T-A7  
10 5/8" - 15"

T-A8  
13 1/4" - 19"

T-A9  
15 7/8" - 23"

T-A10  
18 1/2" - 26 3/4"

T-A11  
21" - 30"

T-A12  
23 1/2" - 34"

T-A13  
26" - 38 1/2"

T-A14  
28 3/4" - 42 1/2"





# Pedestal Premium Calculation

## Pedestal Premium

Adjustable Pedestal Premium works by lifting the jack principal and is applied as one whole piece in corners and edges, reducing costs.

Paving Size	ft <sup>2</sup> /Pcs
11.8"x11.8"	13.8
15.74"x15.74"	7.80
11.81"x23.62"	6.70
15.74"x23.62"	5.20
19.68"x19.68"	5.00
23.62"x23.62"	3.50

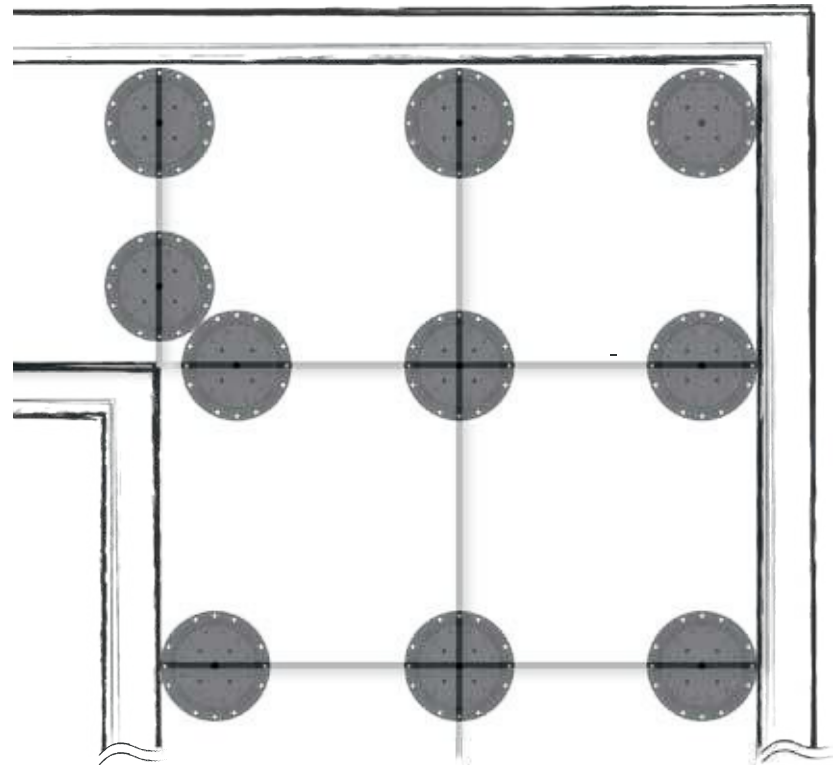

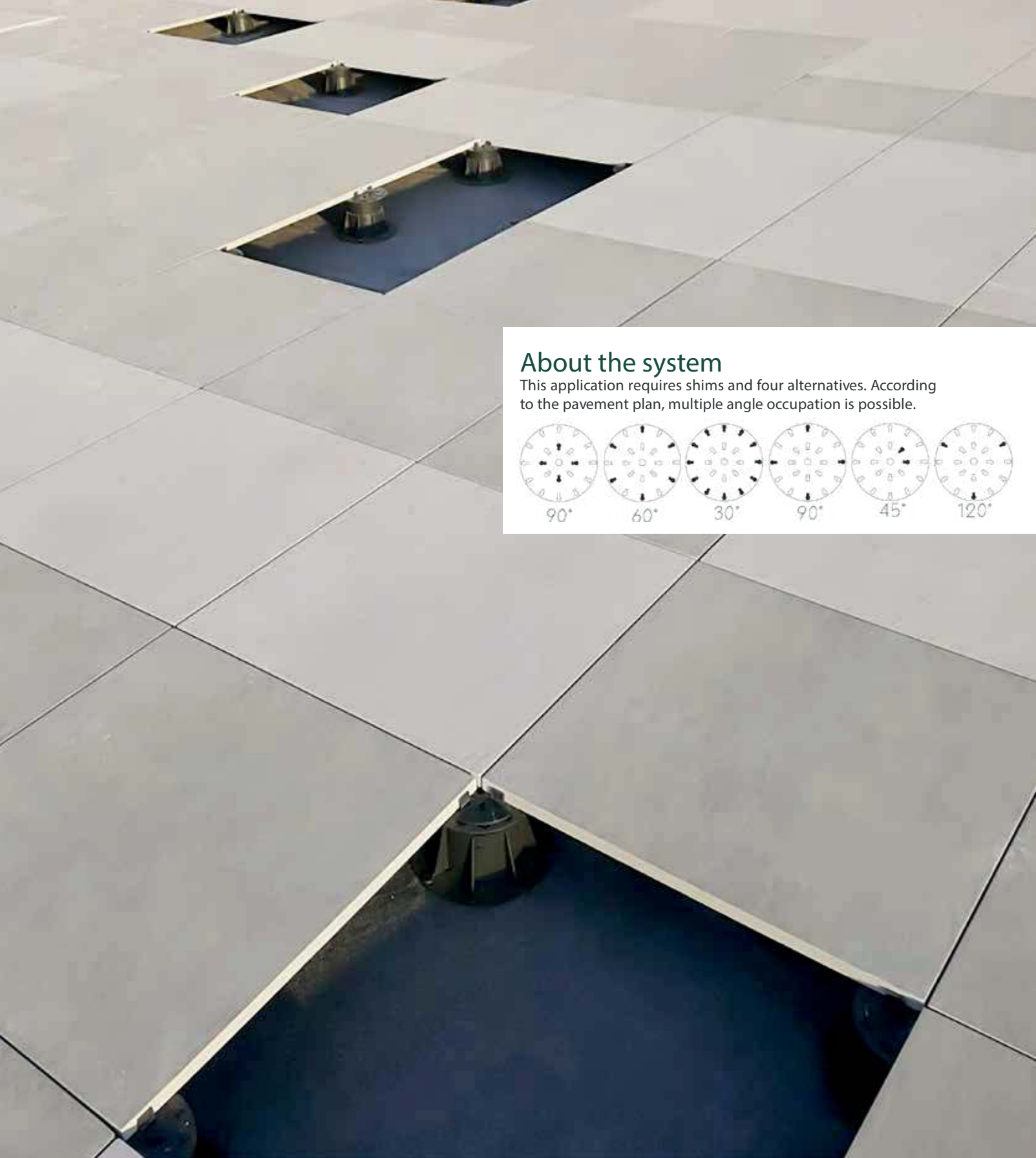

## About the system

This application requires shims and four alternatives. According to the pavement plan, multiple angle occupation is possible.

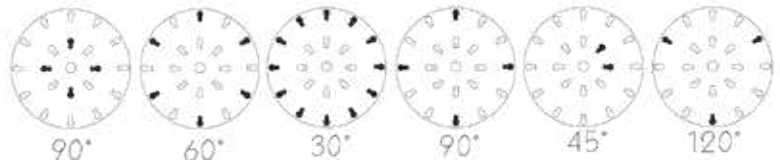



# Tile Paving

## T-SP

Plus shape formed joint strips can sit in the middle of the pedestal and have 4mm thickness. This module can be divided into four different pieces making it easier to use them on tough surfaces. Application can be sped up with this module.



## T-ST

Joint strips are available in 2,4,6 and 8mm thicknesses and can rotate 360°. In addition to the standard height of 0.62", a height of 1.5" is also available.

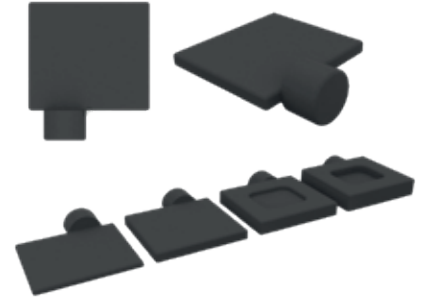

## T-SF

This product can sit on square holes and remain stable. It is better to use them on perfect measured with a set square paving products.



## T-S

Accuracy gasket, made from EPDM, has 0.05" and 0.08" thickness alternatives and is made for avoiding calibration problems of tile pavements. It is placed between coating and plates which helps to absorb vibration. It is recommended to use with every plate module. They can be divided into 4 smaller pieces.

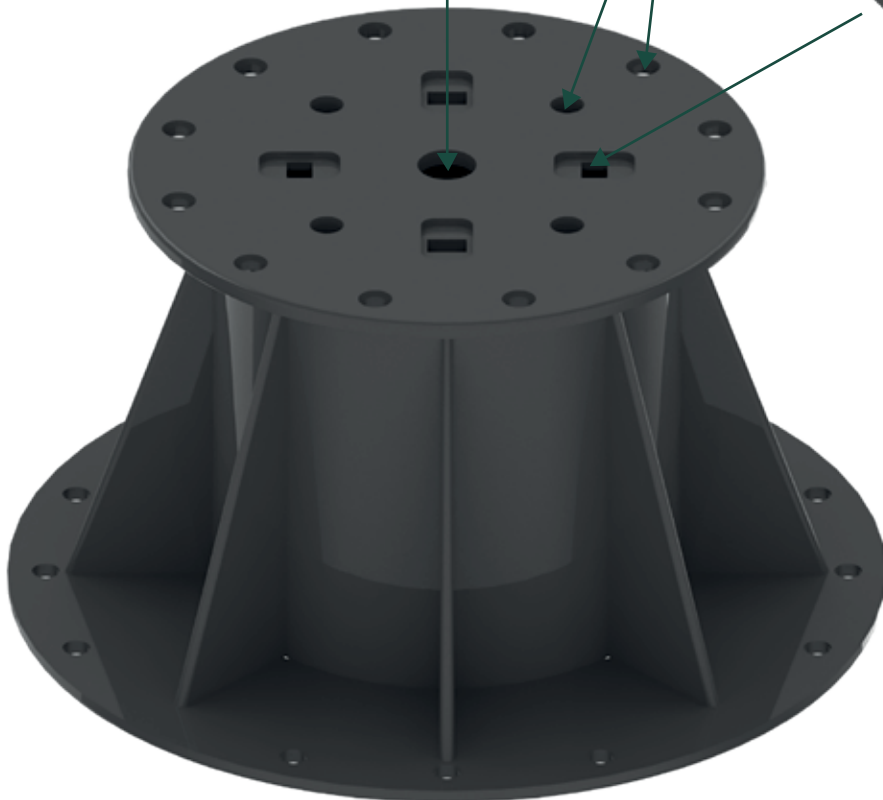







# Lath Paving



## T-AW

Carcass Assembly Equipment is assembled on carcass with auxiliary screws. It is put on the center of pedestal with carcass (Push-on system). It is possible to use all measurements of carcass for this system, even 1cm!



## T-AR

This type of carcass assembly equipment is put in every point on the pedestal except the central point. It should sit face to face and can also turn 360 degrees. Gaps from side walls provide enough space for screws. From 1 cm to 10 cm of carcass can be fitted on this type of equipment.

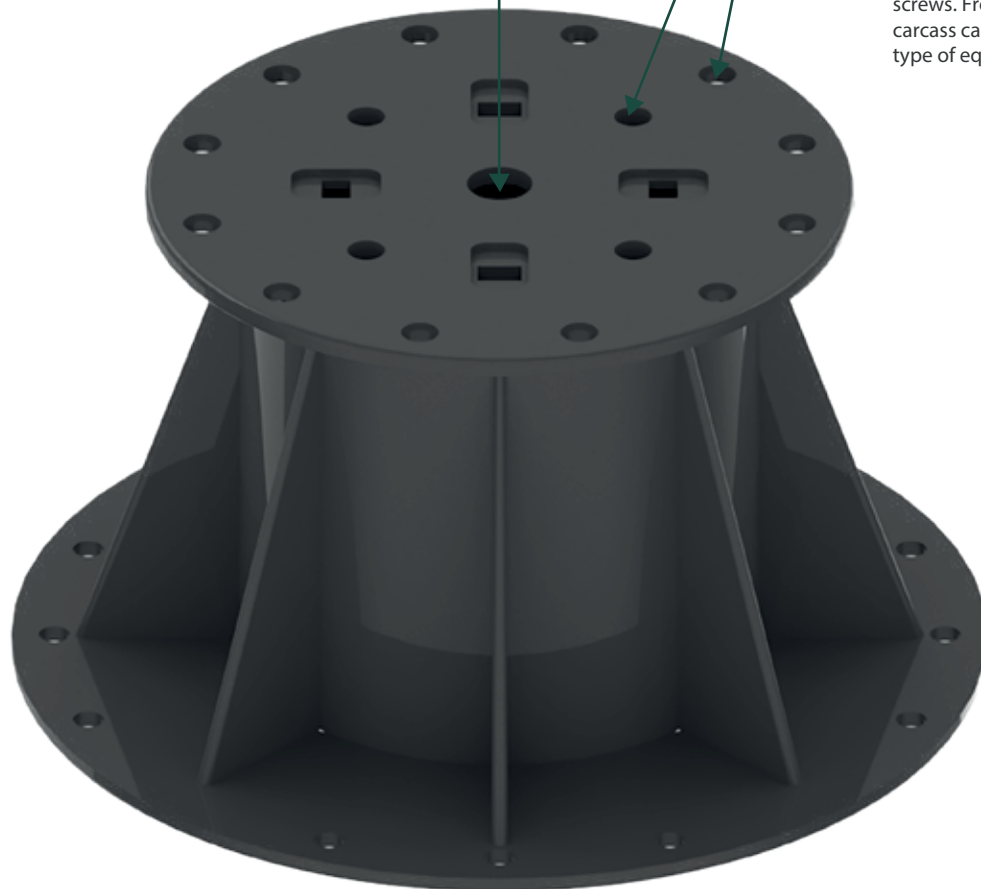





# Slope Correctors

## T-SC

Slope Correctors, sit under the bottom pedestal, and avoid all impacts from drain slopes. 1% and 2% alternatives are available. Slope correctors can be applied either one over another or turnable to get perfect gap angles.

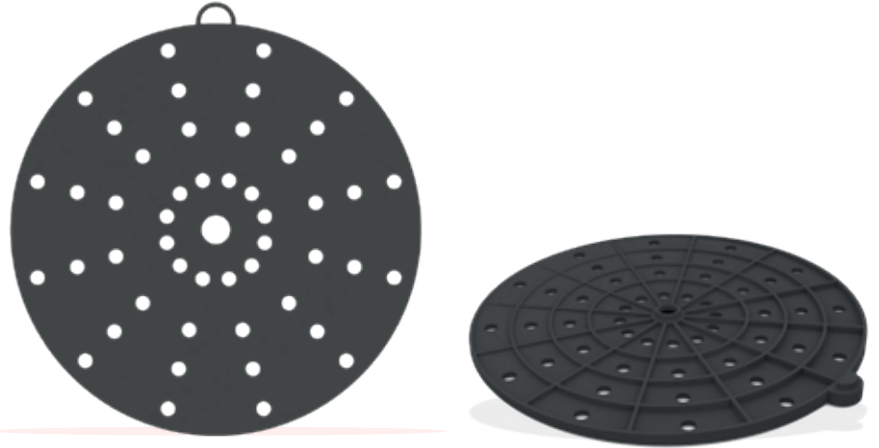

T-SC1

1% grade



T-SC2

2% grade



T-SC1  
T-SC2

3% grade



T-SC2  
T-SC2

4% grade

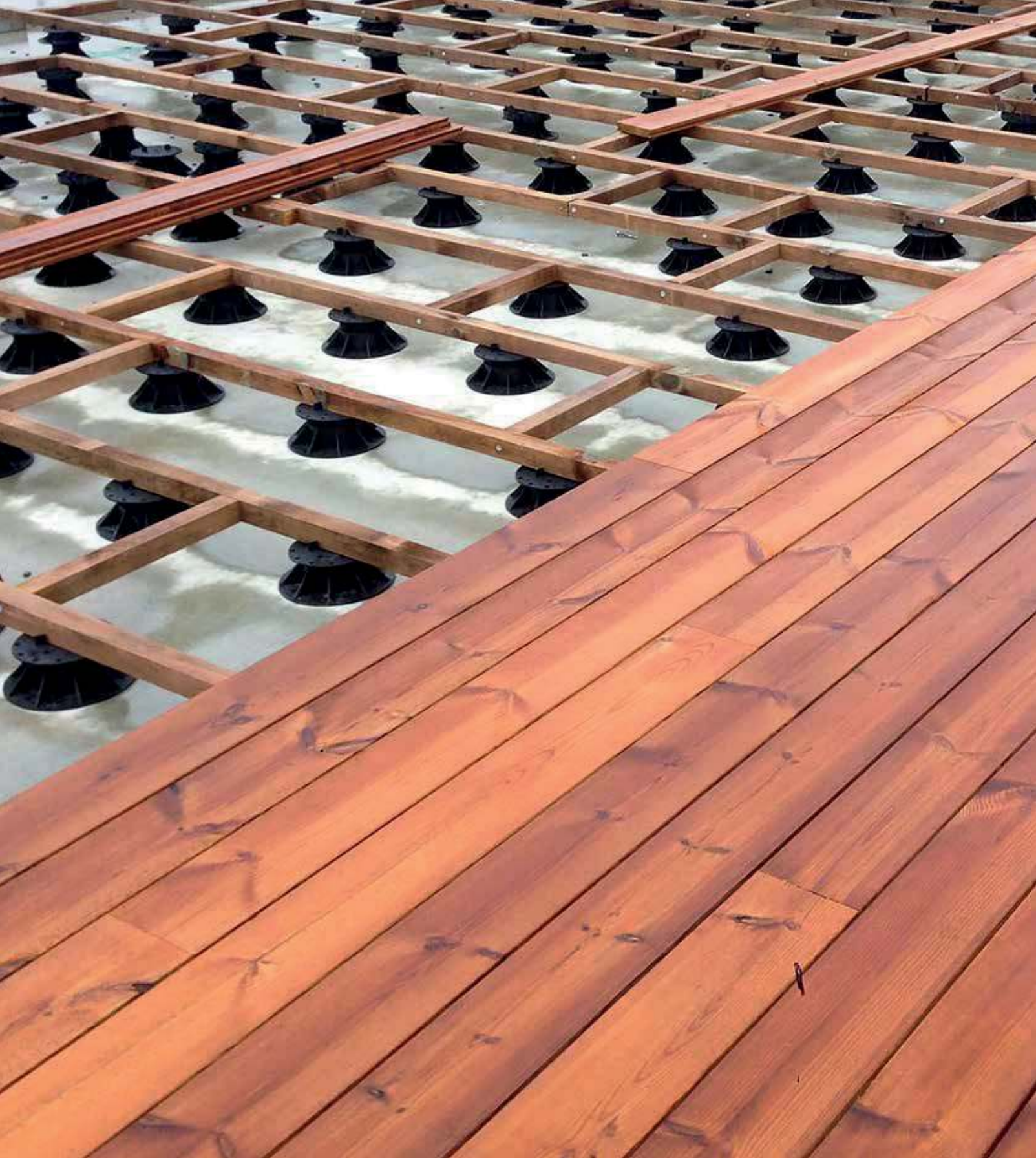

# Orthopedic Floor Pad



## T-P

Made of natural rubber material, the orthopedic floor pad helps to absorb all impact vibrations caused by bumpy surfaces. Thickness is 0.2".



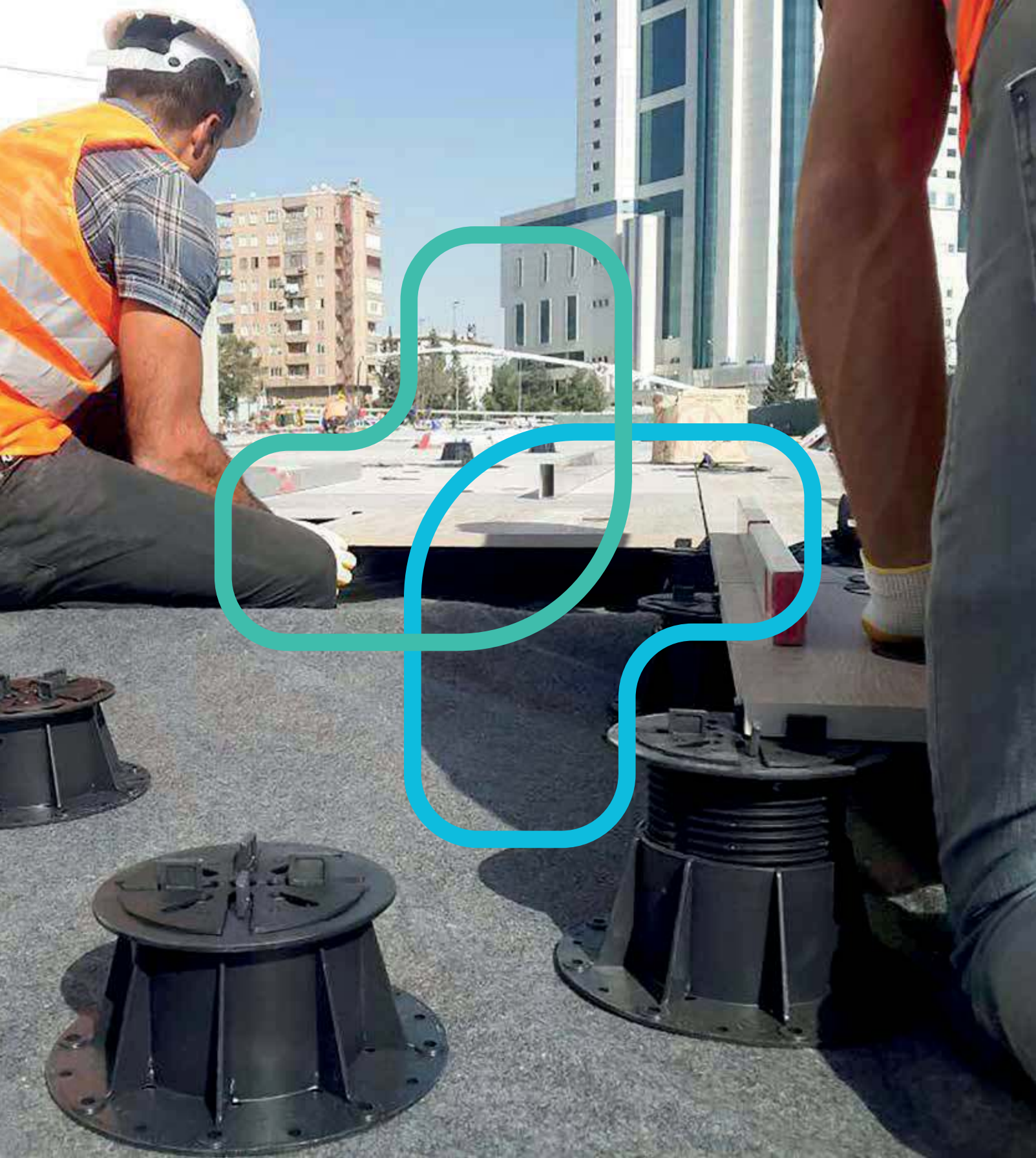

# Lock Out



## T-L

The extruding lock is usually used for high grades. This equipment avoids adjustment corruptions caused by long run vibrations.

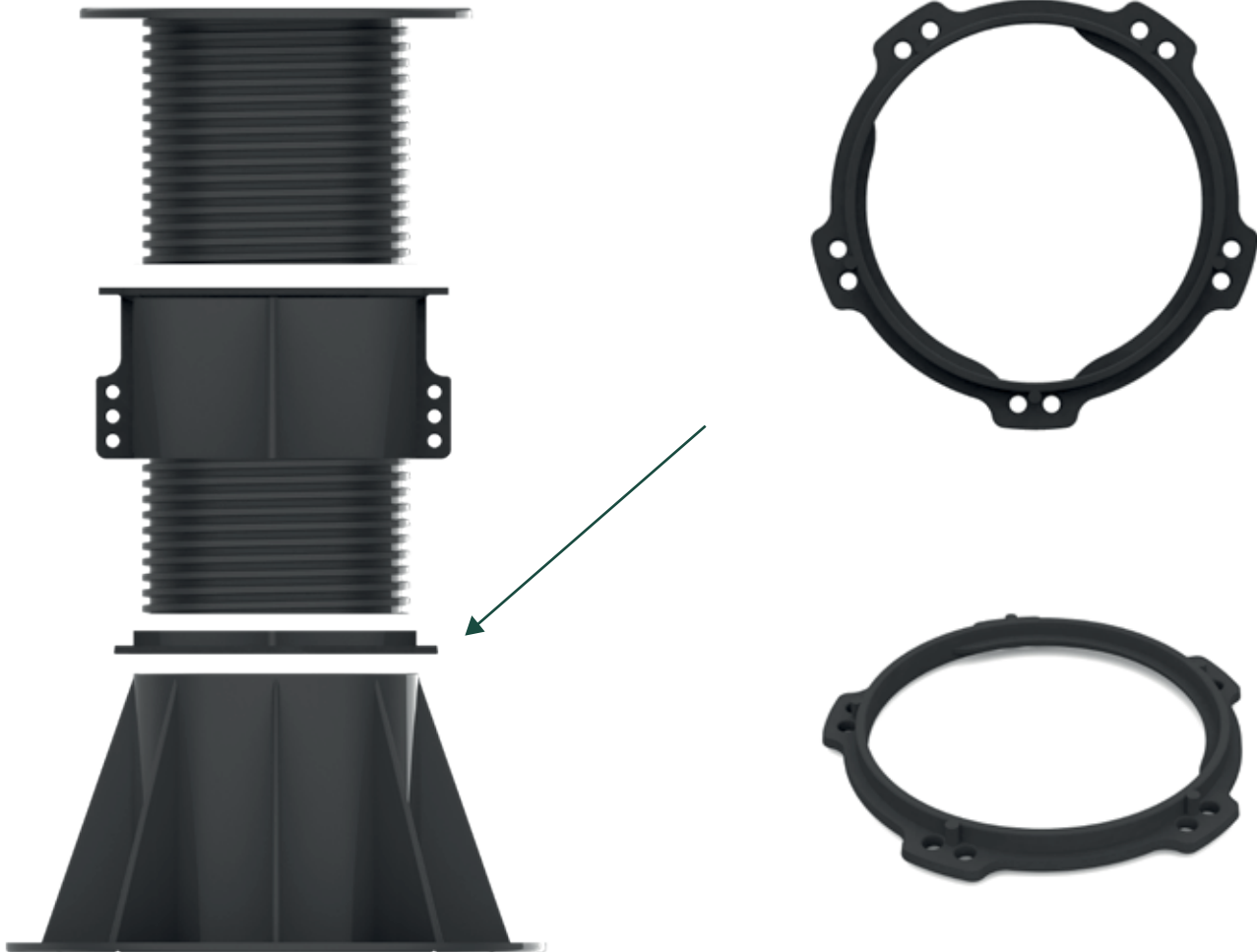

Quick and easy application with no need of corrosion resisting or galvanized steel.





Maxon can be adjusted to any desired grade and avoid slope difference problems. It helps to create a lean and perfectly flat surface



Maxon 

ISO  
9001  
QUALITY  
ASSURANCE